

CITY of PLANO THOROUGHFARE PLAN

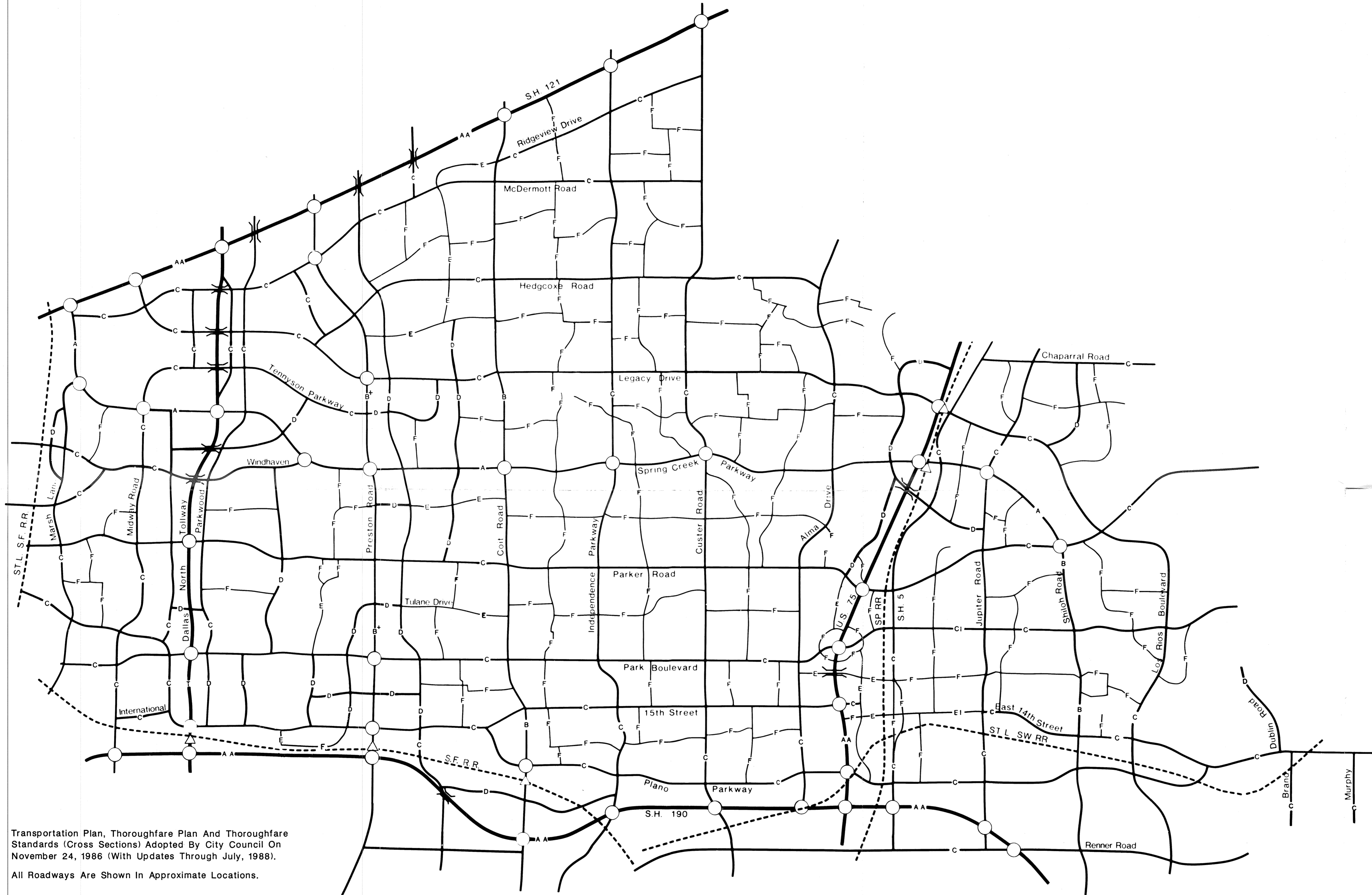

LEGEND

- T AA A Expressway
- B+ B C Major Or Secondary Divided Thoroughfare
- C1 D Thoroughfare
- E E1 F Secondary Undivided Thoroughfare
- Interchange Grade Separation
- △ Rail/Street Grade Separation
- ||| Grade Separation, No Interchange

SCALE 0 1000 2000 4000 10000 FEET

SCALE 0 1/4 1/2 1 2 MILES NORTH

Transportation Plan, Thoroughfare Plan And Thoroughfare Standards (Cross Sections) Adopted By City Council On November 24, 1986 (With Updates Through July, 1988).

All Roadways Are Shown In Approximate Locations.



CITY of PLANO THOROUGHFARE STANDARDS

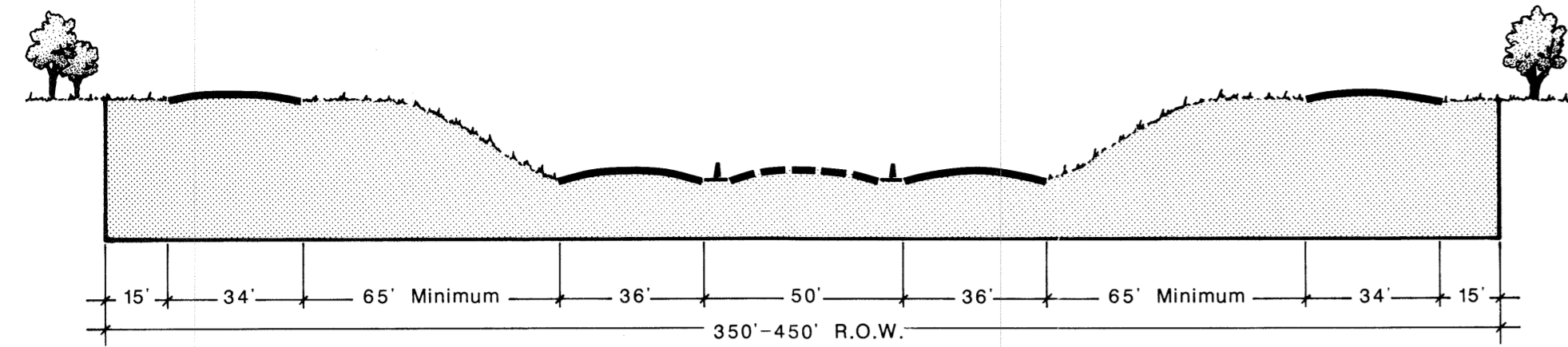

Type T
(E6DF)
Tollway - Regional

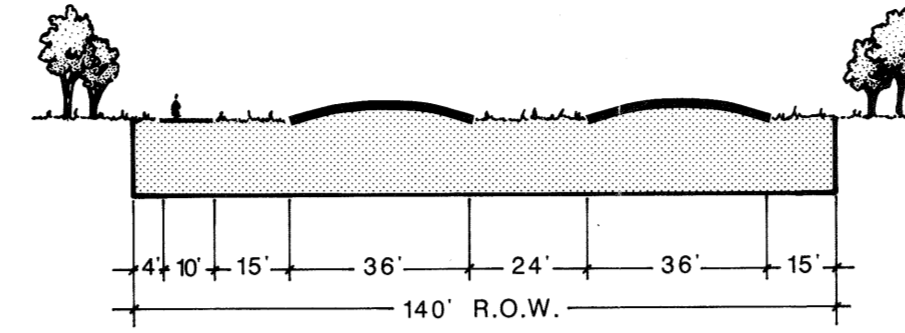

Type B
(M6DAI)
Arterial - Regional
With Bike Path

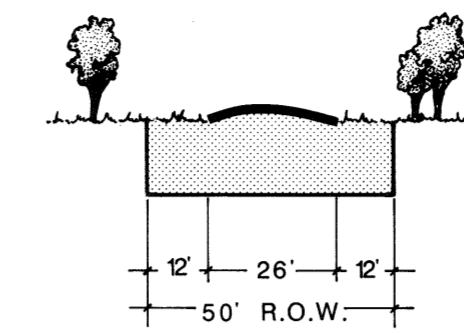

Type G
(R2U)
Residential/Local

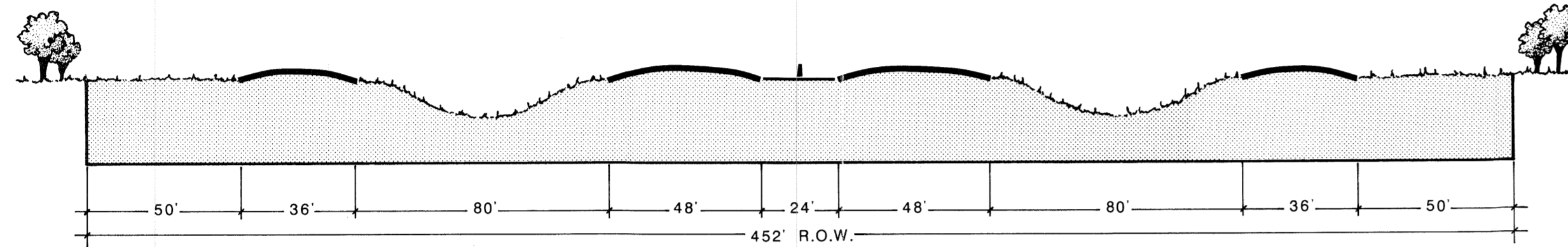

Type AA
(E8DF)
Freeway - Regional

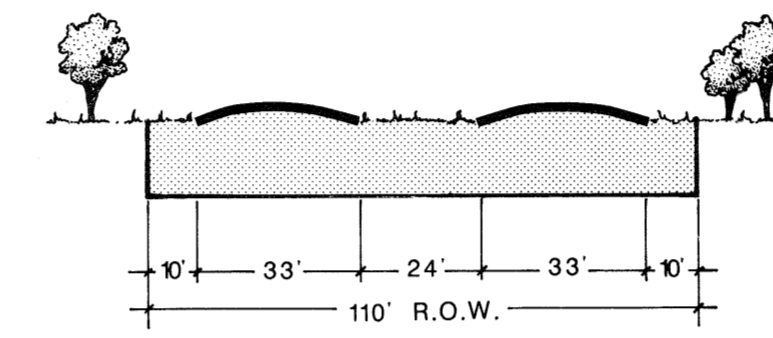

Type C
(M6D)
Major Thoroughfare

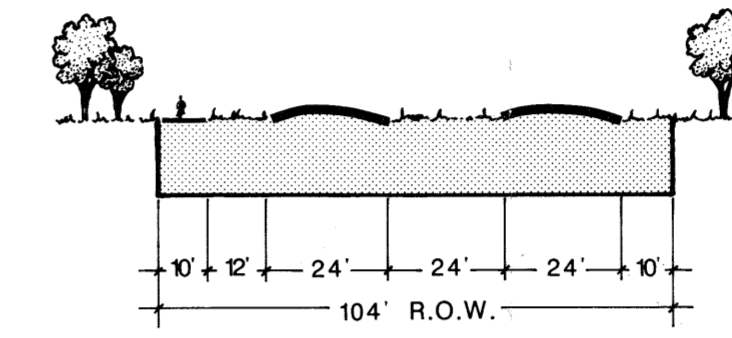

Type D
(S4DI)
Secondary Thoroughfare
With Bike Path

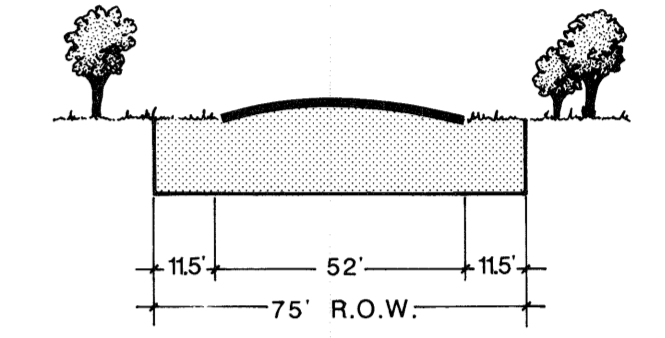

Type E
(S4UIII)
Secondary Thoroughfare
With Bike Route

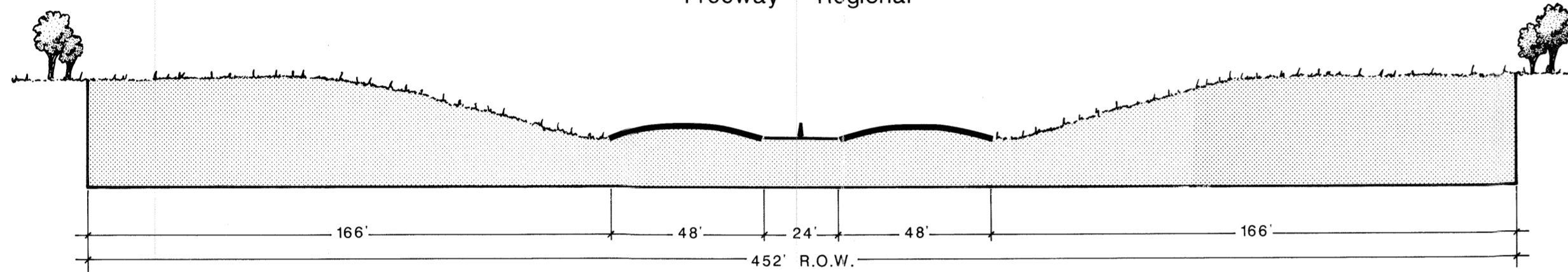

Type AA
(E8DA)
Freeway - Regional

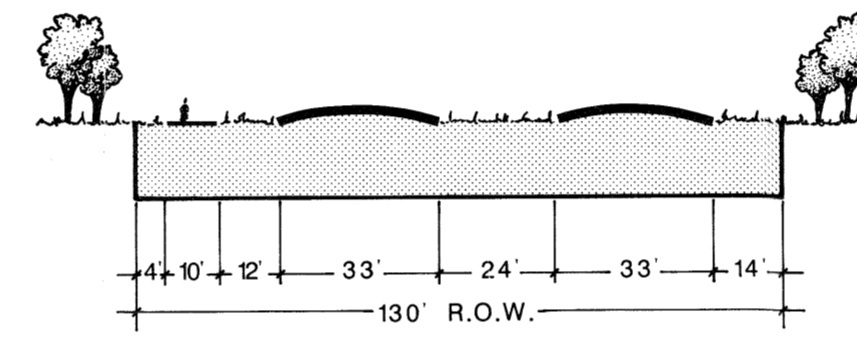

Type C
(M6DI)
Major Thoroughfare
With Bike Path

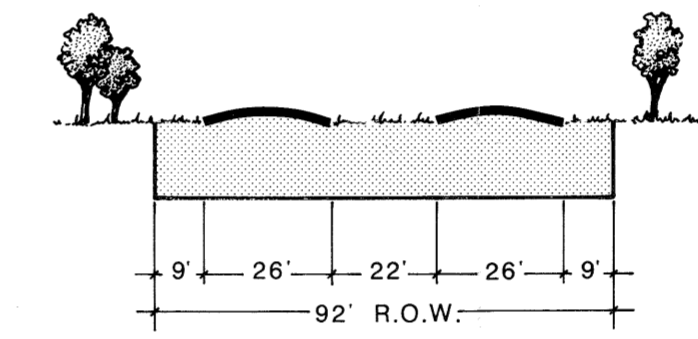

Type D
(S4DIII)
Secondary Thoroughfare
With Bike Route

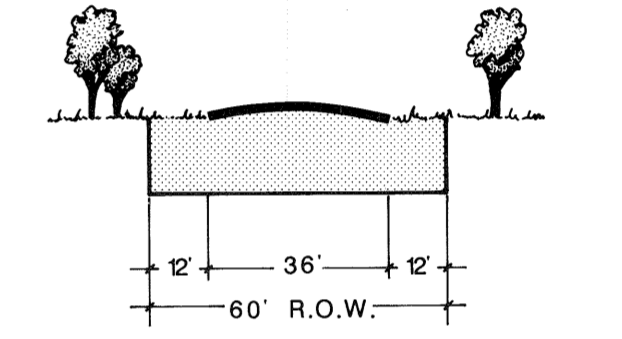

Type F
(S2U)
Collector

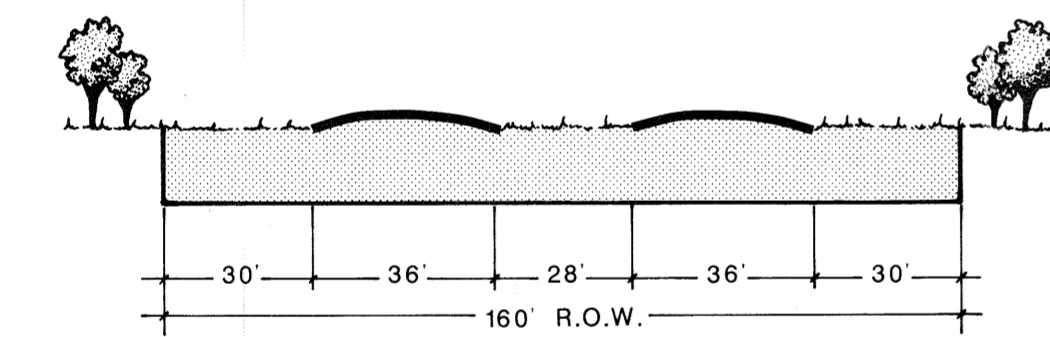

Type A
(E6DA)
Arterial - Regional
Limited Access

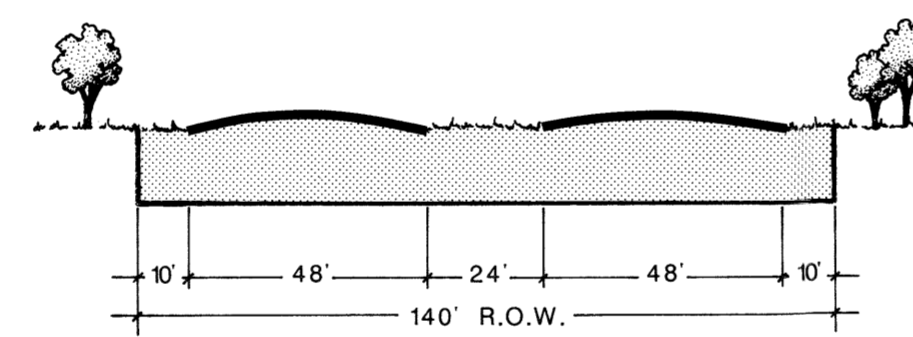

Type B+
(M8DA)
Arterial - Regional
With 12' Access Lanes

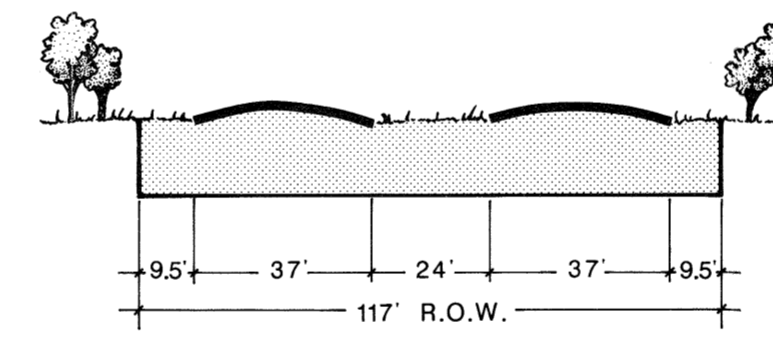

Type C
(M6DIII)
Major Thoroughfare
With Bike Route

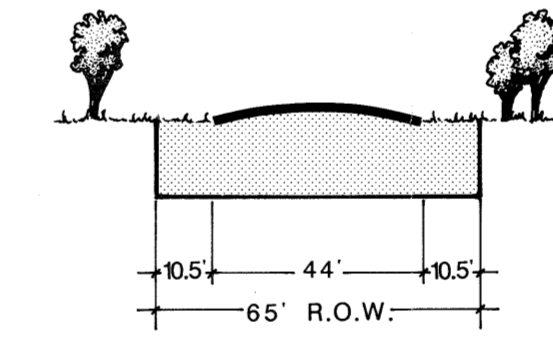

Type E
(S4U)
Secondary Thoroughfare

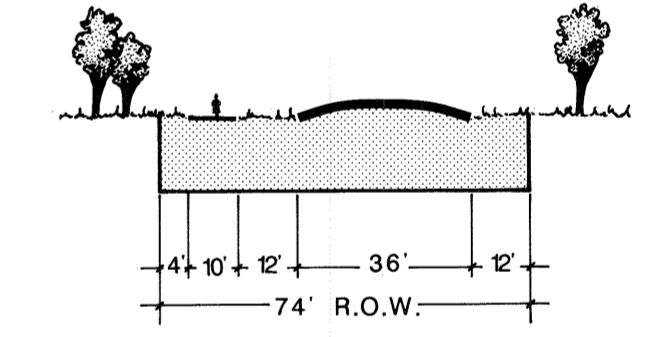

Type F
(S2UI)
Collector
With Bike Path

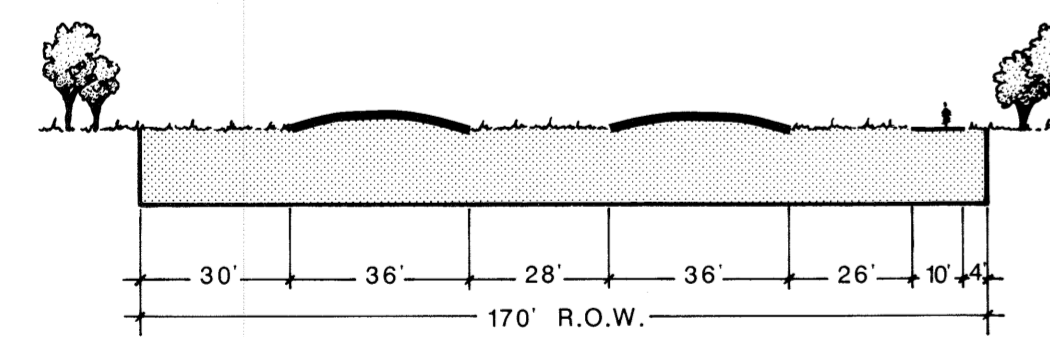

Type A
(E6DAI)
Arterial - Regional
Limited Access
With Bike Path

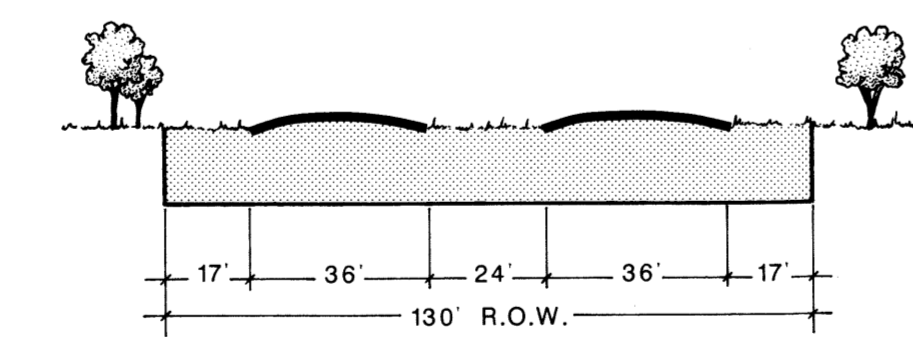

Type B
(M6DA)
Arterial - Regional

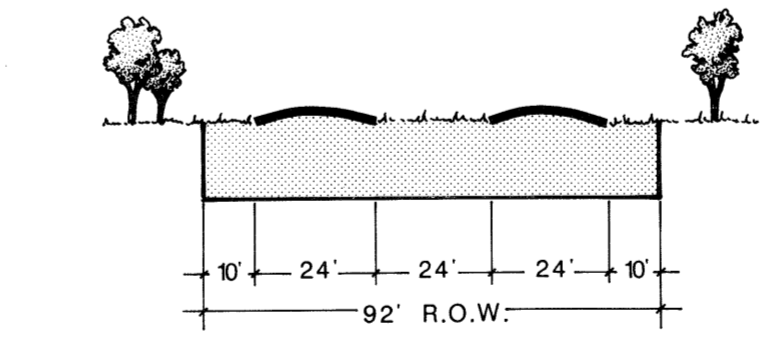

Type D
(S4D)
Secondary Thoroughfare

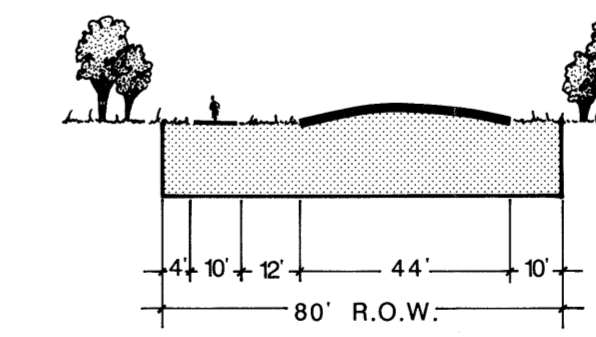

Type E
(S4UI)
Secondary Thoroughfare
With Bike Path

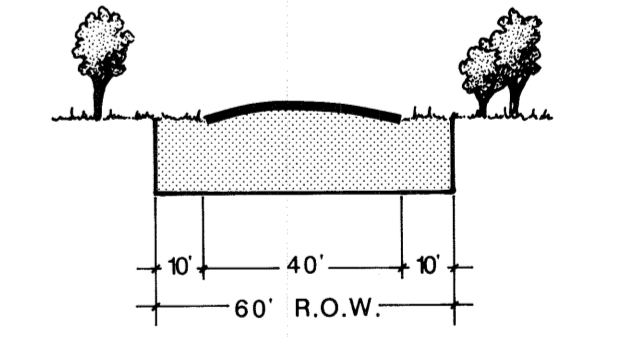

Type F
(S2UIII)
Collector
With Bike Route

